

DF56

smar

MAR / 13
DF56

USER'S MANUAL

Power Supply for Backplane 20 - 30 Vdc



smar
www.smar.com

Specifications and information are subject to change without notice.
Up-to-date address information is available on our website.

web: www.smar.com/contactus.asp

AVOIDING ELECTRICAL DISCHARGES



ATTENTION

Electrostatic discharges may damage semiconductor electronic components in printed circuit boards. They usually occur when touching components or connector pins from modules and racks, without wearing the appropriate equipment to prevent discharges. It is recommended to take the following precautions:

- Before handling modules and racks, remove the electrostatic charge from your body by wearing a proper wristband or touching grounded devices;
- Avoid touching electronic components or connector pins from racks and modules.

DF56 – POWER SUPPLY FOR BACKPLANE 20 – 30 VDC

Description

This redundant power supply works independently or with another redundant power supply module to assure a constant power supply to the application. When two redundant power supply modules are used, both split the energy that is needed to supply the system. When one power supply fails, the other, automatically, will assume the operation. Each power supply has a relay to indicate failures allowing the user to replace damage modules.

This module has two voltage outputs:

- a) **5 Vdc @ 3A** distributed by *Power Lines* in the Inter-Module-Bus (IMB) through racks to supply module circuits.
- b) **24 Vdc @ 300mA** for external use through terminals 1B and 2B.

The DC applied voltage and the 5Vdc and 24 Vdc are isolated.

Installation and Configuration

For systems based on DF92 and DF93 racks, with DF90 and DF91

Redundant mode

Splitting Power concept: In this situation, two modules will supply power to a bus segment. If one of them was turned off or fails, the other power supply must be able to supply energy, alone, to the segment.

Expansion of load capacity by adding power supplies or pairs of redundant power supplies

If the system consumption is greater than 3A, it can be subdivided in up to 8 groups sized for consumption of up to 3A each, and each group is individually powered by a power supply, or redundant pair of power supplies. More details on the Power supplies positioning topic.

Power supplies positions in the racks

On **DF92**, the pair of redundant power supplies must be installed in the first and second slots.

On **DF93** is recommended the placement of the redundant pair in the first and second slots, but it can be installed in any slots if necessary.

Configuration of CH1 jumper

The DF56 **CH1** jumper always must be connected to the **R** position.

For systems based on DF1A and DF78 racks

Single Module: Less than 3 A are required.

There is an address restriction related to the location of the power supply. This restriction is the first rack (address 0) must have a power supply module in the first slot. The **CH1** jumper (power supply) must be set in the **E** position.

More Than One Module: More than 3 A are required.

For systems based on **DF1A** rack they must be placed in the first slot of the rack. Jumper **W1** on the rack that has the new power supply must be cut. Every new power supply will only supply energy to the rack in which it is located and, with the jumper cut off, it will not supply energy to the previous racks. All modules must have the **CH1** jumper (power supply) set in the **E** position.

Redundant Mode:

In redundant mode, the power supply modules must be placed in the first and third slots of rack **DF1A** or first and second slots of rack **DF78**. In both, the **CH1** jumper (power supply) must be set in the **R** position. In this condition, the power supply modules will split the power. This topology is called "split power mode".

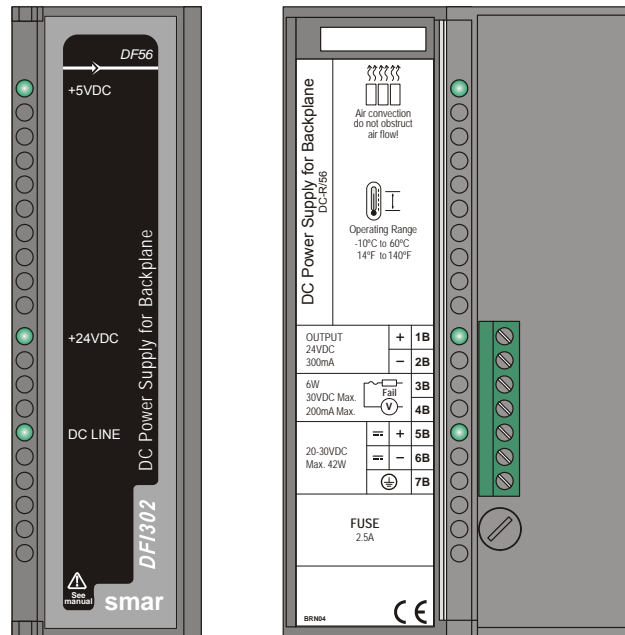

DC Power Supply: DF56

Technical Specifications

INPUTS	
DC	20 to 30 Vdc
Inrush Current	< 20.6 A @ 30 Vdc [$\Delta T < 430 \mu s$]
Maximum Consumption	42 W
Indicator	DC LINE (Green LED)

OUTPUTS	
a) Output1 (Internal Use)	5.2 Vdc +/- 2%
Current	3 A Maximum
Ripple	100 mVpp Maximum
Indicator	+5 Vdc (Green LED)
Hold up Time	> 47 ms @ 24 Vdc [Full Load]
b) Output 2 (External Use)	24 Vdc +/- 10%
Current	300 mA Maximum
Ripple	200 mVpp Maximum
Indicator	+24 Vdc (Green LED)
Short Circuit Current	700 mA

ISOLATION	
Input signal, internal outputs and the external output are isolated between them.	
Between Outputs and Ground	500 Vrms
Between Input and Output	1500 Vrms

FAILURE RELAY	
Type of Output	Solid state relay, normally closed (NC), isolated
Limits	6 W, 30 Vdc Max, 200 mA Max
Maximum Initial Contact Resistance	<13 Ω
Overload Protection	Should be provided externally.
Operation Time	5 ms maximum

TEMPERATURE	
Operation	-10 °C to 60 °C (14 °F to 140 °F)

DIMENSIONS AND WEIGHT	
Dimensions (W x H x D)	39.9 x 137.0 x 141.5 mm (1.57 x 5.39 x 5.57 in)
Weight	0.450 kg

CABLES	
One Wire	14 AWG (2 mm ²)
Two Wires	20 AWG (0.5 mm ²)

NOTES	
1.	If the power consumption exceeds the power supplied, the DF1302 system may operate in an unpredictable manner that may causes damages to the equipment or risk of personal injury. Therefore, the power consumption must be calculated correctly and a detailed analysis should be performed to define the installation of extra power supply modules.
2.	The hardware revisions which are GLL1279 Rev1 and previous revisions do not support redundancy feature.
3.	To meet the EMC standards requirements, the wires' length to the failure relay must be less than 30 meters. The power supply of activated load by the failure relay must not be from external network.

Calculating the Power Consumption

Since the power available in the power supply is limited, it is important to calculate the power consumption of modules in use. The user can create a worksheet to summarize all supplied and required current from each module and associated equipment (such as operator interface).

Example of worksheet with the module's consumption, and some power supplies' specification.

DF1302 Power Budget										
Module	Description	Qty.	Consumption Unit Power (mA)		Total Power (mA)		Supply Unit Power (mA)		Total Power (mA)	
			@24 V	@5 V	@24 V	@5 V	@24 V	@5 V	@24 V	@5 V
DF51	Controller	1	0	950	0	950				
DF62	Controller		0	550	0	0				
DF63	Controller		0	550	0	0				
DF73	Controller		0	650	0	0				
DF75	Controller		0	550	0	0				
DF11	2*8 DI 24 Vdc		0	80	0	0				
DF12	2*8 DI 48 Vdc		0	80	0	0				
DF13	2*8 DI 60 Vdc		0	80	0	0				
DF14	2*8 DI 125 Vdc		0	80	0	0				
DF15	2*8 DI 24 Vdc (sink)		0	80	0	0				
DF16	2*4 DI 120 Vac		0	50	0	0				
DF17	2*4 DI 240 Vac		0	50	0	0				
DF18	2*8 DI 120 Vac		0	87	0	0				
DF19	2*8 DI 240 Vac	2	0	87	0	174				
DF20	8 switches		0	45	0	0				
DF44	8 AI		0	320	0	0				
DF57	8 AI		0	320	0	0				

DFI302 Power Budget										
Module	Description	Qty.	Consumption Unit Power (mA)		Total Power (mA)		Supply Unit Power (mA)		Total Power (mA)	
			@24 V	@5 V	@24 V	@5 V	@24 V	@5 V	@24 V	@5 V
DF45	8 Temperature inputs		0	55	0	0				
DF21	16 DO (transistor)		65	70	0	0				
DF22	2*8 DO (transistor)		65	70	0	0				
DF23	8 DO (triac)		0	70	0	0				
DF24	2*8 DO (triac)		0	115	0	0				
DF25	2*4 DO (relay)		134	20	0	0				
DF26	2*4 DO (relay)		134	20	0	0				
DF27	2*4 DO (relay)		134	20	0	0				
DF28	2*8 DO (relay)		180	30	0	0				
DF29	2*4 DO (relay)		134	20	0	0				
DF30	2*4 DO (relay)		134	20	0	0				
DF31	2*4 DO (relay)		134	20	0	0				
DF46	4 AO		180	20	0	0				
DF32	8 DI 24 Vdc, 4 DO (relay)		67	60	0	0				
DF33	8 DI 48 Vdc, 4 DO (relay)		67	60	0	0				
DF34	8 DI 60 Vdc, 4 DO (relay)		67	60	0	0				
DF35	8 DI 24 Vdc, 4 DO (relay)		67	60	0	0				
DF36	8 DI 48 Vdc, 4 DO (relay)		67	60	0	0				
DF37	8 DI 60 Vdc, 4 DO (relay)		67	60	0	0				
DF38	8 DI 24 Vdc, 4 DO (relay)		67	60	0	0				
DF39	8 DI 48 Vdc, 4 DO (relay)		67	60	0	0				
DF40	8 DI 60 Vdc, 4 DO (relay)		67	60	0	0				
DF53	4 Fieldbus Power Impedance	1	1500	0	1500	0				
TOTAL		4			1500	1074				
DF50		1					300	3000	300	3000
DF52		1					1500	0	1500	0
TOTAL		6							1800	3000

Power supplies and racks positioning

For systems based on DF92 and DF93 racks with DF90 and DF91

A power supply connected to a rack, in a system, provides current to the racks row that are horizontally interconnected to it by their terminals of lateral connections, and vertically through DF90 cables, thus forming a group of rows of racks that use the same power supply.

The system can have only one power supply (or pair of redundant power supplies) or it can be subdivided in several of these groups¹, each one powered by a power supply (or pair of redundant power supplies).

The recommended way to distribute the power is to divide the system in groups of horizontal rows of racks. In this scheme, each power supply must be positioned on the top left of the group of rows of racks that it powers. The rack were is the power supply must be the **W1** jumper cut and the DF90 cable must not be connected to the rows powered by other power supplies (top rows). See in the following figure an example of system powered by two power supplies, each one powers a part of rows represented in green and blue.

¹ Maximum 8 groups allowed when the DF56 power supplies are used.

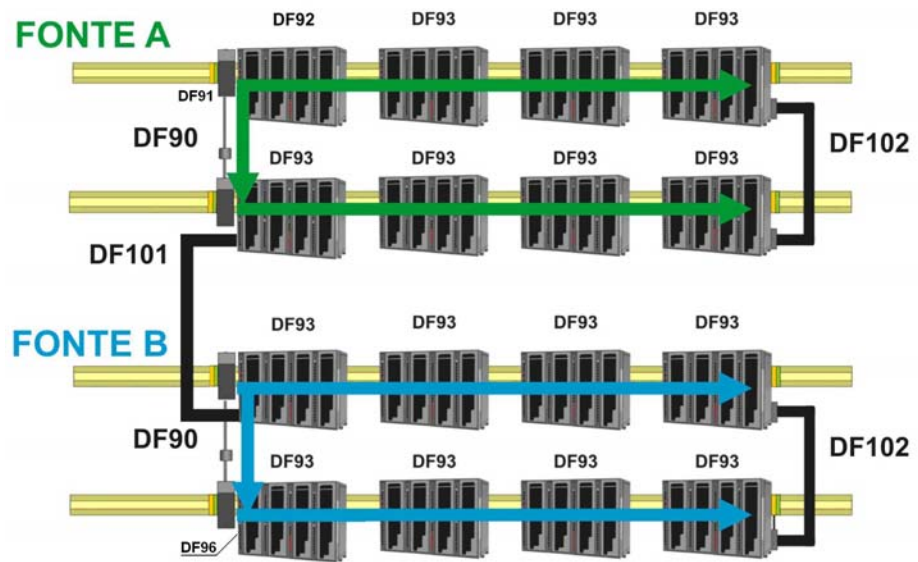

System powered by two power supplies

Note that this system, for greater efficiency, is optimized for power distribution by groups of rows of racks. Thus, a power supply powers a whole number of rows it supports. However, in rare cases, with long rows or many modules with great consumption in the same row, there is the option to add power supplies in the middle of the row, dividing the power within this row. In this case, the power supply added powers only the modules positioned on the right in the same row, up to the end, or even where there is another power supply added. In the rack where the power supply was added, in this scheme, the **W1** jumper must be cut and left lateral connection terminal (+5 Vdc) must be disconnected (collapsed).

In this system, **DF56** must be its **CH1** jumper always configured in **R**, even if it is not in redundant pair.



ATTENTION

A mixture of these power supplies with the **CH1** configured in **R** and in **E** in any **DFI302** system, is not allowed!

On DF92, the pair of redundant power supplies must be installed in the first and second slots.

On DF93 is recommended the placement of the redundant pair in the first and second slots, but it can be installed in any slots if necessary.

The system has diagnostic for voltage level distributed to racks. It also supports modules with great power consumption in any place on the bus. Nevertheless, is recommended to place those modules close to the power supplies, to avoid unnecessary power transmission.

For systems based on DF78 and DF1A Racks (legacy systems)

1. Observe the maximum current values from the power supply module specification. The limit for DF56 is 3 A.
2. After the connection with long cables (DF4A, DF5A, DF6A and/or DF7A) you have to put another power supply module in the first slot of the first rack.
3. Use up to 6 modules DF44/DF57 per power supply; always place consecutively the DF44/DF57 and close to the power supply. Because of the high current consumption of the modules DF44/DF57, a not desired voltage drop in the bus can occur if these modules are placed after other modules.
4. When is necessary to add interface modules, such as HI302, MB700, DF58, in the same bus which is used by output and input modules, is recommended that these modules are placed close to



the power supply, because in the same way as described in the previous item, a not desired voltage drop in the bus can occur if these modules are placed after other modules.

5. Adding a new power supply module

- Determine the rack where the new power supply will be installed.
- Cut the jumper **W1** of the rack.
- Plug the new power supply at the first slot of the rack (slot 0).
- In this case, the **CH1** jumper of all modules DF56 must be set in **E** position.

Installing Modules in the Rack

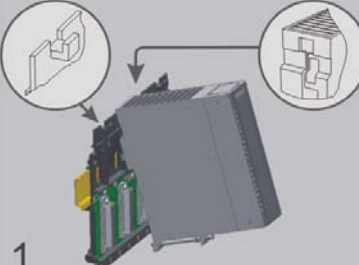
Follow the steps below to install a module in the rack.

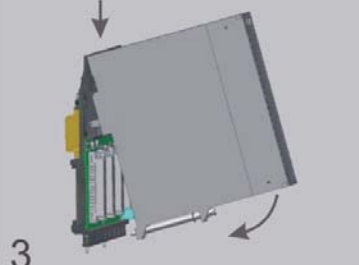
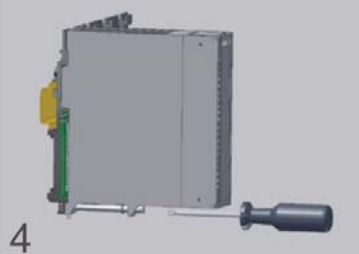
 <p>1</p>	<p>Attach the top of the module (with a 45° inclination) to the module support located on the upper part of the rack.</p>
 <p>2</p>	<p>Mounting detail.</p>
 <p>3</p>	<p>Push the module fixing it to the module connector.</p>
 <p>4</p>	<p>Next, fix the module to the rack using a screwdriver, and fasten the fixation screw at the bottom of the module.</p>

Appendix

	SRF – SERVICE REQUEST FORM	
	DFI302 – Fieldbus Universal Bridge	Proposal N°: _____
COMPANY INFORMATION		
Company: _____ Unit: _____ Invoice: _____		
COMMERCIAL CONTACT		
Full Name: _____ Phone: _____ Fax: _____ E-mail: _____		
TECHNICAL CONTACT		
Full Name: _____ Phone: _____ Extension: _____ E-mail: _____		
EQUIPMENT DATA		
Model: _____ Serial Number: _____		
PROCESS DATA		
Process Type (Ex. boiler control): _____ Operation Time: _____ Failure Date: _____		
FAILURE DESCRIPTION		
(Please, describe the failure. Can the error be reproduced? Is it repetitive?)		
_____ _____ _____ _____		
OBSERVATIONS		
_____ _____ _____ _____		
USER INFORMATION		
Company: _____ Contact: _____ Section: _____ Title: _____ Signature: _____ Phone: _____ Extension: _____ E-mail: _____ Date: ____/____/____		
For warranty or non-warranty repair, please contact your representative. Further information about address and contacts can be found on www.smar.com/contactus.asp		

